

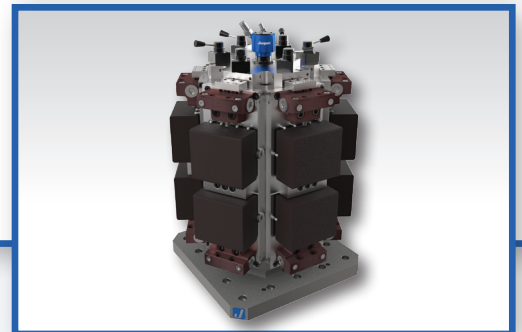

# Jergens®

## WORKHOLDING CAPABILITIES FOR HORIZONTAL MACHINES

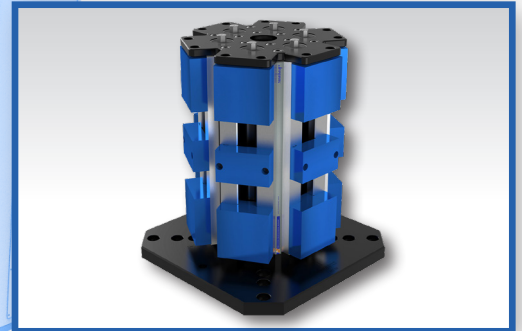
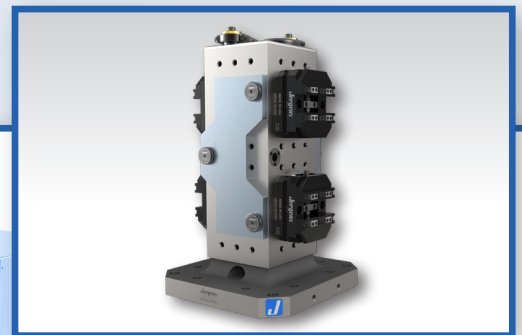
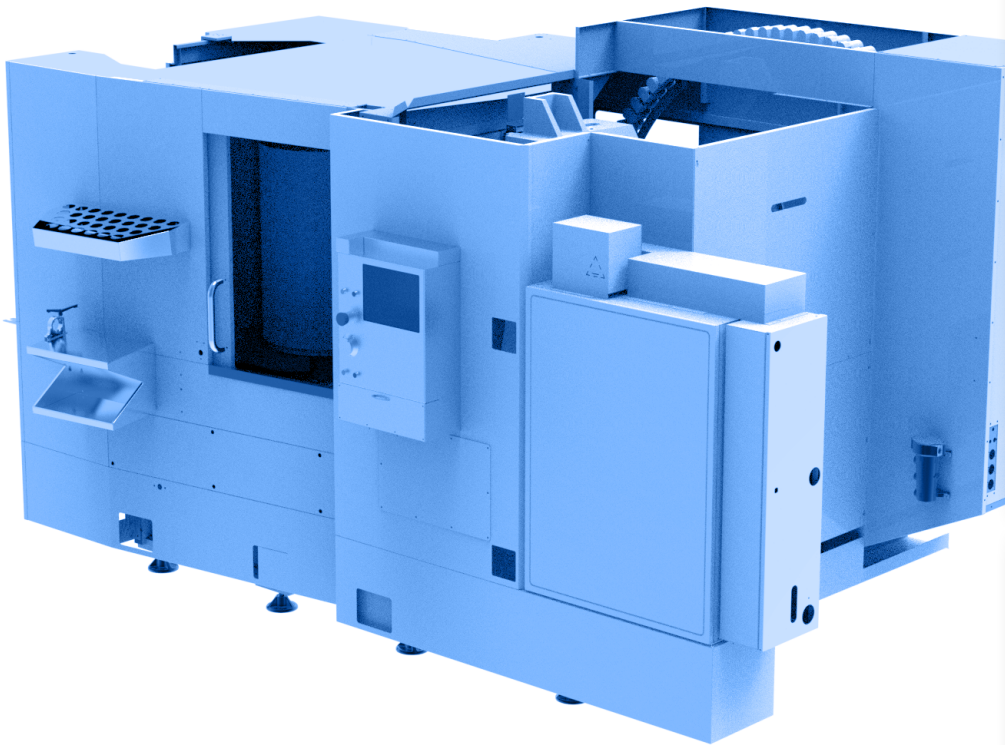

# NEED TO DISCUSS YOUR APPLICATION WITH ONE OF OUR ENGINEERS?

## ONLINE ENGINEER SUPPORT SERVICE

Scan the QR code to set up a 1-on-1 with a Jergens Engineer!



### VIEW MORE JERGENS CAPABILITIES

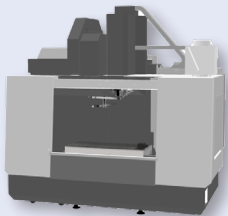

**VERTICAL**

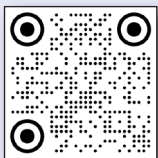

**AUTOMATION**

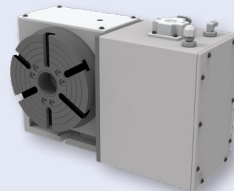
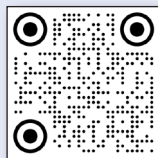

**ROTARY**

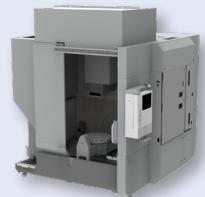
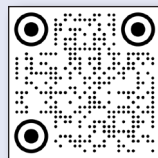

**5-AXIS**

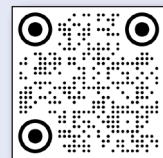



# JERGENS WORKHOLDING CAPABILITIES FOR HORIZONTAL MACHINES

WORKHOLDING COMPONENTS

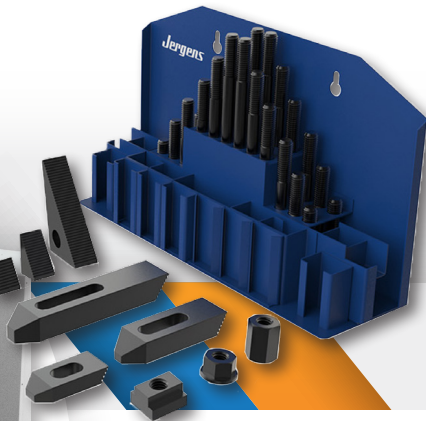

TOGGLE CLAMPS

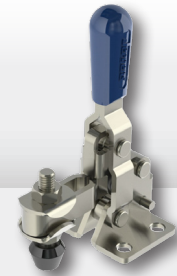

SELF-CENTERING VISE

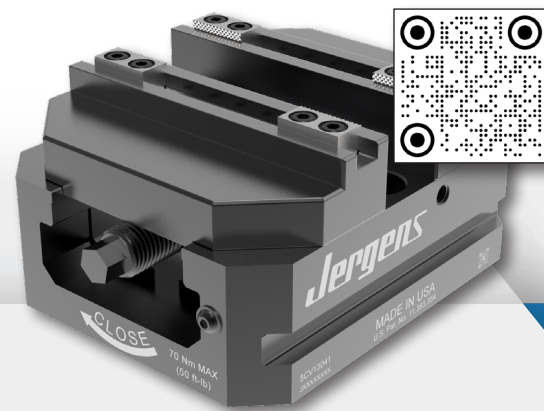

TOOLING COLUMNS

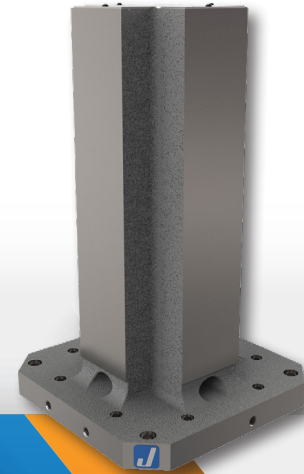

OK-VISE

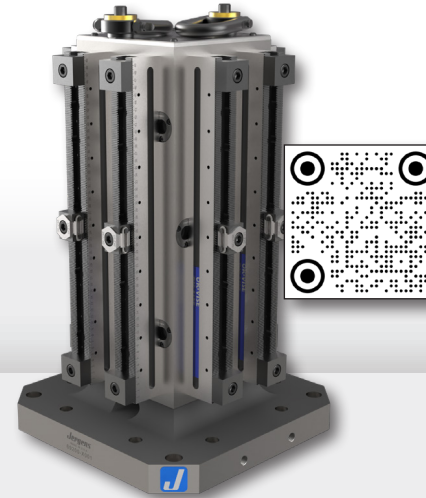

BALL LOCK®



ZERO POINT SYSTEM (ZPS)

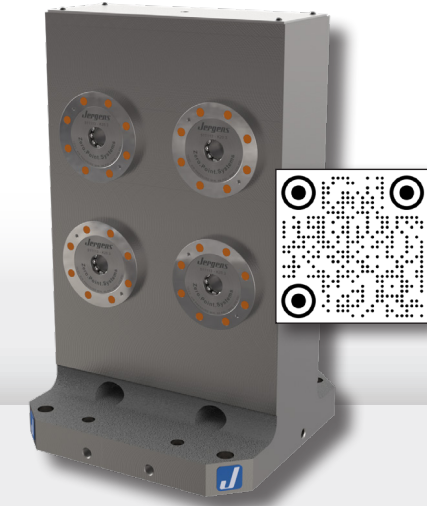

STANDARD COMPONENTS

QUICK-CHANGE SYSTEMS

CUSTOM ENGINEERED SOLUTIONS

LOCATING COMPONENTS



HEAVY DUTY MACHINE VISE

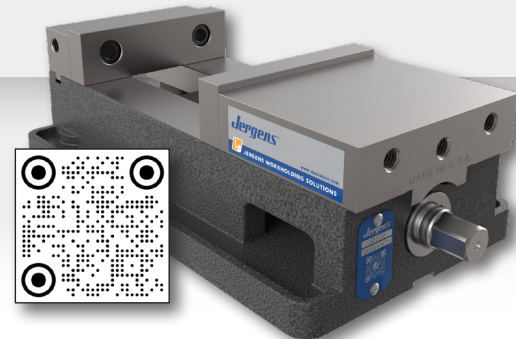

PRODUCTION VISE COLUMNS

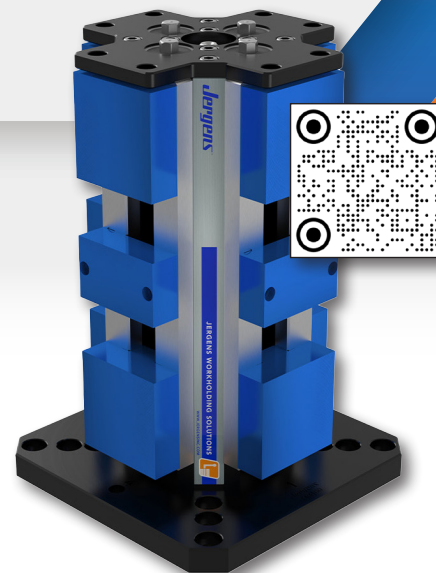

POWER WORKHOLDING



QUICK-LOC™

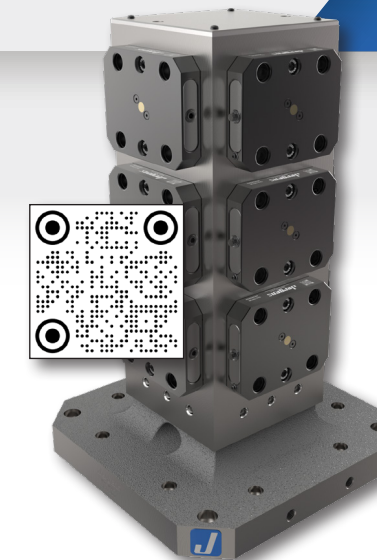

CUSTOM DESIGN & BUILD

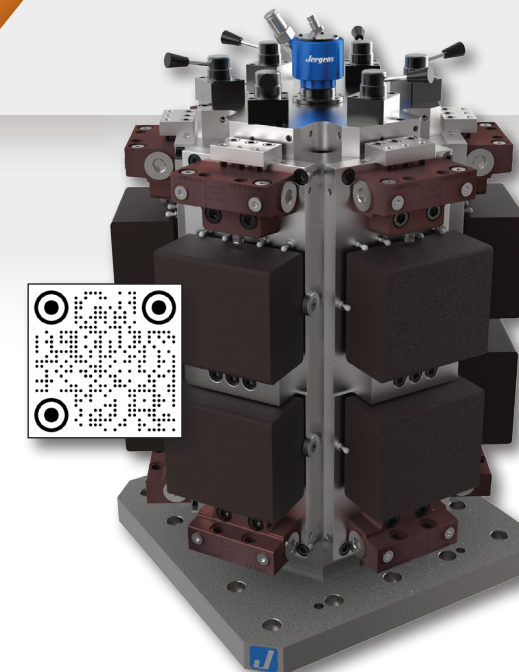

# Jergens®

## WORLD HEADQUARTERS

15700 S. WATERLOO ROAD  
CLEVELAND, OH 44110-3898

 877.426.2504

 [JERGENSINC.COM/WORKHOLDING](http://JERGENSINC.COM/WORKHOLDING)

 [WORKHOLDING@JERGENSINC.COM](mailto:WORKHOLDING@JERGENSINC.COM)

FIND OUR WORKHOLDING PRODUCTS  
AND SUPPORTING INFO ONLINE.

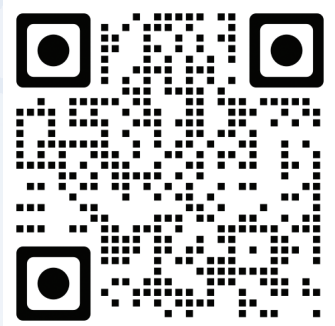

DISTRIBUTED BY:



WORKHOLDING SOLUTIONS



SPECIALTY FASTENERS



LIFTING SOLUTIONS

©2023 JERGENS, INC.

